

# **GASCOIGNE LUMBER CO.**

Dedicated to the prosperity of the Independent Lumber Yard  
Our words and our actions are the same

**APRIL 1, 2024 – WHOLESALE DISTRIBUTOR**

**QUALITY & SERVICE  
MOULDINGS & MILLWORK  
FINISH LUMBER & DOORS**



**WAREHOUSE:**

2310 36th St.

Everett, WA 98206

**MAILING ADDRESS:**

P.O. Box 1502

Everett, WA 98206

[www.gascoignelumber.com](http://www.gascoignelumber.com)

**OFFICE HOURS:**

M-F, 7:00 a.m. to 4:00 p.m.

**WILL CALL HOURS:**

M-F, 7:30 a.m. to 3:30 p.m.

Local Line

Fax Line

Toll Free WA/AK/HI

E-mail

206-282-4314

206-282-7178

1-800-282-1426

[contact@gascoignelumber.com](mailto:contact@gascoignelumber.com)

# PRODUCT INDEX

**Douglas Fir Lumber - Mouldings..... 1-3**  
**Shiplap - Tongue & Groove - Stepping..... 4-5**  
**Hemlock Lumber - Mouldings ..... 6-10**  
**Finger-Joint Primed Pine Lumber - Mouldings ..... 11-12**  
**Ultralite - Lite MDF Boards..... 12**  
**Ultralite - Lite MDF Mouldings ..... 13**  
**Mahogany Lumber - Mouldings ..... 14**  
**Red Oak Lumber - Mouldings..... 15-16**  
**Alder Lumber - Mouldings..... 17**  
**Maple Lumber - Mouldings ..... 17**  
**Pine Lumber..... 18**  
**Poplar Lumber ..... 18**  
**Hemlock Jambs ..... 19-20**  
**Finger-Joint Primed Jambs..... 21**  
**Fir Veneer - Knotty Alder - Clear Pine Jambs..... 22**  
**Wood Sills - Jamb Stock - Mull Post - Astragals - Shims..... 23**  
**Thresholds - Sills - Door Shoes - Extenders - Weatherstripping ..... 24-25**  
**Cedar Lattice..... 26**  
**Post Caps - Packaged Paneling ..... 27**  
**Soft Corners - Rosettes - Plinth Blocks ..... 28**  
**Doors ..... 29-40**  
**Miscellaneous Information ..... 41-42**

## Looking for something that isn't in this book?

Different species; custom mouldings & millwork patterns; special jambs and door parts — we can get them, or at least point you in the right direction.

Here are some questions to ask your customer:

- |   |   |
|---|---|
| 1. What are they using the material for?  | 4. What lengths will they use? More flexibility = better availability.                    |
| 2. What appearance/species/grade do they want?                                    | Do they have a cut list?  |
| 3. How much/many do they need? (Use the table on page 5 to convert sq. ft. to LF) | 5. Do they need to match an existing pattern <i>exactly</i> ? "Close enough" saves money. |



April 1, 2024









# DOUGLAS FIR MOULDINGS

	<i>order #</i>	<i>description</i>	<i>lengths</i>	<i>bdl.</i>	<i>suggested retail per LF</i>
	F-051	9/16 x 3-1/4 Crown (VG)	R/L	(6)	
	F-126	1/2 x 3/4 Base Shoe (MG)	R/L	(20)	
	F-151	7/16 x 9/16 Bevel Bead (MG)	6-12'	(20)	
	F-155	3/8 x 7/16 Glass Bead (MG)	6-12'	(20)	
	F-180	1-1/4 x 2 Brick Mould (MG)	7'	(4)	
	F-180	1-1/4 x 2 Brick Mould (MG)	R/L	(4)	
	F-181	1-1/4 x 1-9/16 Brick Mould (MG)	R/L	(8)	
	F-188	1-1/16 x 1-5/8 Drip Cap (MG)	R/L	(8)	
	F-190	1-5/16 x 2-3/8 Drip Cap (MG)	R/L	(4)	
	F-200	1-5/16 x 3 Corner Post (MG) (2 x 4)	R/L	(PC)	
	F-265	1/4 x 2-1/4 Batten (VG)	8', 10', 12'	(20)	

(Prices subject to change)

April 1, 2024

# DOUGLAS FIR MOULDINGS

	<i>order #</i>	<i>description</i>	<i>lengths</i>	<i>bdl.</i>	<i>suggested retail per LF</i>
	F-278	1-1/8 x 1-5/16 Back Band (MG)	R/L	(6)	
	F-283	1-3/8 x 2-7/16 Cap Mould (MG)	R/L	(4)	
	F-356	11/16 x 2-1/4 Colonial Csg (VG)	7'	(8)	
	F-356	11/16 x 2-1/4 Colonial Csg (VG)	R/L	(8)	
	F-412	11/16 x 3-1/2 DBN Casing (VG)	7'	(6)	
	F-412	11/16 x 3-1/2 DBN Casing (VG)	R/L	(6)	
	F-452	11/16 x 2-1/2 DBN Casing (VG)	7'	(6)	
	F-452	11/16 x 2-1/2 DBN Casing (VG)	R/L	(6)	
	F-623	5/8 x 3-1/4 OG Base (VG)	R/L	(6)	
	F-732	1/2 x 3-1/2 BN Base (VG)	R/L	(6)	
	F-909	1-1/16 x 3-1/4 Stair Nosing (VG)	R/L	(PC)	
	F-952	7/16 x 1-1/4 Fillet (MG)	R/L	(20)	
	F-1021	7/8 x 5-3/8 French Stool (VG)	R/L	(PC)	









(Prices subject to change)

April 1, 2024



# SHIPLAP - TONGUE & GROOVE - STEPPING

## DOUGLAS FIR SAND BEFORE FINISHING

*suggested  
retail  
per LF*

<i>size</i>	<i>description</i>	<i>dimensions</i>	<i>face</i>	<i>suggested retail per LF</i>
<b>DOUGLAS FIR FLOORING (6'-20')</b>				
	1x4 C & Btr. VG	3/4 x 3-3/8	3-1/8	
	1x4 C & Btr. MG	3/4 x 3-3/8	3-1/8	
<b>DOUGLAS FIR NICKEL GAP / #132 V-JOINT PANELING (6'-16')</b>				
	5/8x6 Select Tight Knot	9/16 x 5-1/4	4-15/16	
<b>DOUGLAS FIR RUSTIC SHIPLAP (6'-16')</b>				
	1x6 Rustic	11/16x5-1/2	5	
<b>DOUGLAS FIR #132 V-JOINT PANELING / FLOORING (6'-20')</b>				
	1x6 C & Btr. VG	11/16x5-3/8	5-1/8	
<b>DOUGLAS FIR #106 DROP SIDING (6'-20')</b>				
	1x6 C & Btr. MG	11/16 x 5-5/16	5-1/8	
<b>DOUGLAS FIR BEADED CEILING / CENTER V GROOVE (6'-20')</b>				
	5/8x4 C & Btr. MG	9/16 x 3-1/4	3-1/16	
<b>DOUGLAS FIR BEADED CEILING / #132 V-JOINT PANELING (6'-20')</b>				
	5/8x6 C & Btr. MG	9/16 x 5-3/16	5	
<b>DOUGLAS FIR STEPPING (6'-20')</b>				
	5/4 x 12 C & Btr. VG	1 x 11-1/8		

## PINE SAND BEFORE FINISHING

<b>PONDEROSA PINE WP 4 &amp; 6 PANELING (6'-16')</b>				
	1x6 #2 & Btr.	11/16 x 5-3/8	5	
	1x8 #2 & Btr.	11/16 x 7-1/8	6-3/4	
<b>PONDEROSA PINE STEPPING (6' - 16')</b>				
	5/4 x 12 #2 & Btr	1-3/16 x 11-1/4		



(Prices subject to change)

April 1, 2024

# SHIPLAP - TONGUE & GROOVE - STEPPING

## HEMLOCK SAND BEFORE FINISHING



*suggested  
retail  
per LF*

size	description	dimensions	face	
<b>HEMLOCK BEADED CEILING / #132 V-JOINT PANELING (6'-20')</b>				
	5/8x4 C & Btr. MG	9/16 x 3-5/16	3-1/8	
	5/8x6 C & Btr. VG	9/16 x 5-3/8	5-3/16	

## PRIMED



**WINDSORONE PRIMED FINGER JOINT PINE** (Interior & Exterior Use, 30 year Warranty)

	5/8x4 Beaded Ceiling (16')	9/16 x 3-5/16	3-1/8	
	1 x 6 Beaded Ceiling (16')	3/4 x 5-3/8	5-3/32	
	1 x 8 Shiplap Smooth Face/Rough Face (16')	3/4 x 7-1/4	6-1/2	

**PRIMED FINGER JOINT PINE** (for interior & exterior)

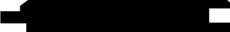
	1x6 Nickel Gap/#132 V-Joint (16')	5/8 x 5-1/2	4-15/16	
---	-----------------------------------	-------------	---------	--

## SQUARE FOOT TO LINEAL FOOT COVERAGE ESTIMATOR

This estimator helps you determine the lineal footage needed for your paneling, flooring, or ceiling project.

Find the face width below that matches the material you are using. Multiply the "Area Factor" by the square footage you need to cover (length x width x factor). Result is the minimum lineal foot quantity of material you need. Remember to add 10% to this calculation to allow for waste and trim!

FACE WIDTH	AREA FACTOR
3	4
3 1/16	3.92
3 1/8	3.84
3 1/4	3.69
3 1/2	3.43
3 3/4	3.2
4	3
4 1/4	2.82
4 1/2	2.67
4 3/4	2.53
4 15/16	2.43

FACE WIDTH	AREA FACTOR
5	2.4
5 3/32	2.36
5 1/8	2.34
5 3/16	2.31
5 1/4	2.29
5 1/2	2.18
5 3/4	2.09
6	2
6 1/8	1.96
6 1/4	1.92

FACE WIDTH	AREA FACTOR
6 1/2	1.85
6 3/4	1.78
7	1.71
7 1/8	1.68
7 1/4	1.66
7 1/2	1.6
7 3/4	1.55
8	1.5
8 1/4	1.45

(Prices subject to change)

April 1, 2024

# HEMLOCK

## QUALITY S4S FINISH LUMBER

**RANDOM LENGTH 6' - 20', CALL FOR SPECIFIED LENGTH AVAILABILITY**  
**DETAILED CUT LISTS APPRECIATED - SAND BEFORE FINISHING**

### VERTICAL GRAIN - C & BETTER

<i>dimensions</i>	<i>suggested retail per LF</i>
1/2 x 3 .....	
1/2 x 4 (also see H-732 Base).....	
1/2 x 5 .....	
1/2 x 6 (also see H-736 Base).....	
1/2 x 8.....	

1 x 2 .....	
1 x 3 (also see H-452 Casing).....	
1 x 4 (also see H-412 Casing).....	
1 x 5 .....	
1 x 6 .....	
1 x 7 .....	
1 x 8 .....	
1 x 10.....	
1 x 12.....	
5/4 x 4.....	
5/4 x 6.....	
5/4 x 8.....	

### VERTICAL GRAIN - C & BETTER

<i>dimensions</i>	<i>suggested retail per LF</i>
2 x 2 .....	
2 x 4 .....	
2 x 6 .....	
2 x 8 .....	

### MIXED GRAIN - C & BETTER

<i>dimensions</i>	<i>suggested retail per LF</i>
1 x 3 .....	
1 x 4 .....	
1 x 5 .....	
1 x 6 .....	
1 x 8 .....	

## Hemlock mouldings on the next page...

### Remember that build-ups can help!

Give your customers' project a unique look, make them feel more involved in the design process, replicate old/unusual profiles at a fraction of the cost of a custom run, and sell more mouldings!

#### Examples of Crown Build-ups

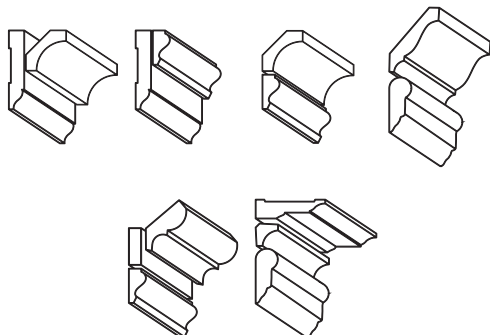

#### Examples of Base Moulding Build-ups

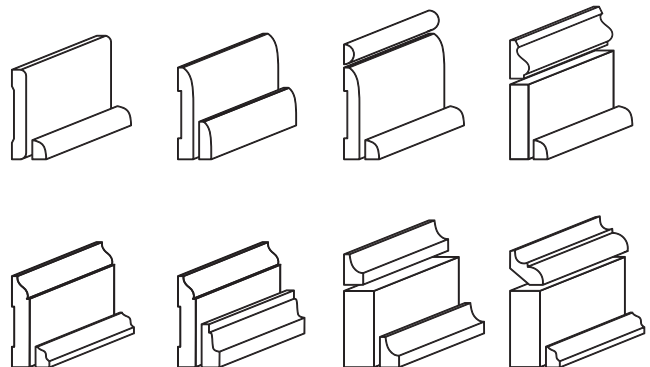



April 1, 2024

# HEMLOCK MOULDINGS













	<i>order #</i>	<i>description</i>	<i>lengths</i>	<i>bdl.</i>	<i>suggested retail per LF</i>
	H-042	1-3/16 x 2-1/4 Crown	8', 10', 12'	(8)	
	H-044	9/16 x 1-1/4 Crown	8', 10', 12'	(12)	
	H-046	1/2 x 11/16 Crown	8', 10', 12'	(20)	
	H-049	1/2 x 3-9/16 Crown	8',10',12',14',16'	(8)	
	H-054	1/2 x 2-1/4 Crown	8',10',12',14',16'	(8)	
	H-068	7/16 x 1-5/8 Crown	8', 12'	(12)	
	H-074	9/16 x 1-3/4 Bed Mould	8',10',12',14',16'	(10)	
	H-084	9/16 x 2-1/4 Cove	8', 10', 12'	(8)	
	H-086	9/16 x 1-9/16 Cove	8', 10', 12'	(10)	
	H-100	11/16 x 11/16 Cove	8', 10', 12'	(20)	
	H-101	1/2 x 1/2 Cove	8', 10', 12'	(20)	
	H-105	3/4 x 3/4 Quarter Rd	8', 10', 12'	(20)	
	H-108	1/2 x 1/2 Quarter Rd	8', 10', 12'	(20)	
	H-109	3/8 x 3/8 Quarter Rd	8', 10', 12'	(20)	
	H-110	1/4 x 1/4 Quarter Rd	8', 10', 12'	(20)	
	H-116	3/4 x 1-1/2 Half Round	8', 10', 12'	(12)	
	H-120	1/2 x 1 Half Round	8', 10', 12'	(20)	
	H-122	3/8 x 3/4 Half Round	8', 10', 12'	(20)	
	H-124	1/4 x 1/2 Half Round	8', 10', 12'	(20)	
	H-126	1/2 x 3/4 Base Shoe	8', 10', 12'	(20)	
	H-142	1/4 x 3/4 BN Screen Mould	8', 10', 12'	(20)	
	H-173	5/8 x 3/4 Base Cap	8',10',12',14',16'	(20)	
	H-180	1-1/4 x 2 Brick Mould	7',8',10',12',18'	(4)	
	H-181	1-1/4 x 1-9/16 Brick Mould	7',8',10',12'	(8)	

**MORE HEMLOCK MOULDINGS ON NEXT PAGE!**

*(Prices subject to change)*

April 1, 2024

# HEMLOCK MOULDINGS (CONT'D)

	<i>order #</i>	<i>description</i>	<i>lengths</i>	<i>bdl.</i>	<i>suggested retail per LF</i>
	H-182	9/16 x 1-9/16 Panel Mould	8', 10', 12'	(12)	
	H-184	1/2 x 1 Shadow Box	8', 10', 12'	(20)	
	H-204	1-5/16 x 1-5/16 O.S. Corner	8', 10', 12'	(10)	
	H-205	1-1/16 x 1-1/16 O.S. Corner	8', 10', 12'	(20)	
	H-206	3/4 x 3/4 O.S. Corner	8', 10', 12'	(20)	
	H-231	1-5/16 x 1-5/8 Hand Rail	8' & Lgr	(4)	
	H-232	1-5/8 Full Round	R/L	(4)	
	H-233	1-5/16 Full Round	R/L	(10)	
	H-234	1 Full Round	8', 10', 12'	(12)	
	H-235	3/4 Full Round	8', 10', 12'	(20)	
	H-238	1-1/16 x 1-1/16 Square	8', 10', 12'	(10)	
	H-239	3/4 x 3/4 Square	8', 10', 12'	(20)	
	H-240	1-1/4 x 2-1/4 Hand Rail (2 x 3)	8', 10', 12', 14', 16', 18'	(4)	
	H-254	1/2 x 3/4 Parting Bead	8', 10', 12'	(20)	
	H-264	1/4 x 2-1/8 Lattice	8', 10', 12'	(20)	
	H-266	1/4 x 1-5/8 Lattice	8', 10', 12'	(20)	
	H-267	1/4 x 1-3/8 Lattice	8', 10', 12'	(20)	
	H-269	1/4 x 1-1/16 Lattice	8', 10', 12'	(20)	
	H-273	5/8 x 1-3/4 Picture Mould	8', 10', 12', 14', 16'	(12)	
	H-280	1-1/8 x 1-1/8 Back Band	R/L	(8)	
	H-283	1-3/8 x 2-7/16 Cap Mould	R/L	(4)	

**MORE HEMLOCK MOULDINGS ON NEXT PAGE!**

*(Prices subject to change)*

April 1, 2024

# HEMLOCK MOULDINGS (CONT'D)











	<i>order #</i>	<i>description</i>	<i>lengths</i>	<i>bdl.</i>	<i>suggested retail per LF</i>
	H-291	5/8 x 1-3/8 Panel Cap	8', 10', 12'	(12)	
	H-292	9/16 x 1-1/8 Wainscot Cap	8', 10', 12'	(20)	
	H-293	3/4 x 1-15/16 Panel Cap	8', 10', 12'	(6)	
	H-296	9/16 x 2-1/2 Chair Rail	8', 10', 12'	(8)	
	H-297	11/16 x 3 Chair Rail	8', 10', 12'	(6)	
	H-300	9/16 x 1-1/2 Wedge Csg	7', 8', 10', 12'	(12)	
	H-324	9/16 x 2-1/4 Wedge Csg	7', 8', 10', 12'	(8)	
	H-325	9/16 x 1-9/16 S/L Csg	7', 8', 10', 12'	(12)	
	H-327	9/16 x 2-1/4 S/L Csg	7', 8', 10', 12'	(8)	
	H-340	9/16 x 2-1/4 Moulded Csg	7', 8', 10', 12'	(8)	
	H-341	5/8 x 3-1/4 Moulded Csg	8', 10', 12'	(8)	
	H-344	11/16 x 3-1/4 Colonial Csg	8', 10', 12'	(8)	
	H-356	11/16 x 2-1/4 Colonial Csg	7', 8', 10', 12', 14', 16'	(8)	
	H-384	9/16 x 2-1/4 OG Csg	7', 8', 10', 12'	(8)	
	H-393	9/16 x 1-9/16 Beaded Csg	7', 8', 10', 12'	(12)	
	H-395	9/16 x 2-1/2 Beaded Csg	7', 8', 10', 12'	(8)	
	H-396	5/8 x 3-1/4 Beaded Csg	8', 10', 12'	(8)	
	H-412	11/16 x 3-1/2 DBN Csg (VG Solid)	7', 8', 10', 12'	(6)	
	HV-412	11/16 x 3-1/2 DBN Csg (VG Veneer)	7', 8'	(6)	

**MORE HEMLOCK MOULDINGS ON NEXT PAGE!**

*(Prices subject to change)*

April 1, 2024

# HEMLOCK MOULDINGS (CONT'D)

	<i>order #</i>	<i>description</i>	<i>lengths</i>	<i>bdl.</i>	<i>suggested retail per LF</i>
	H-442	9/16 x 2-1/4 Beaded Csg	7', 8', 10', 12'	(8)	
	H-452	11/16 x 2-1/2 DBN Csg (VG Solid)	7', 8', 10', 12'	(6)	
	HV-452	11/16 x 2-1/2 DBN Csg (VG Veneer)	7', 8'		
	H-470	1/2 x 1-1/2 DBN Casing	7', 8', 10', 12'	(12)	
	H-473	1/2 x 2-1/4 DBN Casing	7', 8', 10', 12'	(8)	
	H-480	9/16 x 3-1/4 Fluted/Beaded Csg	8'	(8)	
	H-508	11/16 x 2-1/2 Universal Mould	8', 12'	(8)	
	H-612	3/8 x 3-1/4 Colonial Base	8', 12'	(8)	
	H-615	9/16 x 1-9/16 Wedge Base	8', 10', 12'	(12)	
	H-618	9/16 x 5-1/4 OG Base	8', 10', 12', 14', 16'	(6)	
	H-623	7/16 x 3-1/4 OG Base	8', 10', 12', 14', 16'	(8)	
	H-625	7/16 x 2-1/4 OG Base	8', 10', 12', 14', 16'	(8)	
	H-723	7/16 x 3-1/4 S/L Base	8', 10', 12', 14', 16'	(8)	
	H-726	7/16 x 2-1/4 S/L Base	8', 10', 12', 14', 16'	(8)	
	H-732	1/2 x 3-1/2 BN Base (VG)	R/L	(6)	
	H-736	1/2 x 5-1/2 BN Base (VG)	R/L	(4)	
	H-790	11/16 x 2-1/4 Sanitary Base	8', 10', 12'	(8)	
	H-796	9/16 x 1-1/2 Sanitary Base	8', 10', 12'	(12)	
	H-845	7/16 x 1-7/16 S/L Base	8', 10', 12'	(12)	
	H-863	7/16 x 2-1/4 Bullnose Stop	8', 10', 12'	(8)	
	H-865	7/16 x 1-5/8 Bullnose Stop	8', 10', 12'	(12)	
	H-866	1/2 x 1-3/8 Bullnose Stop	8', 10', 12'	(20)	
	H-869	1/2 x 1-1/16 Bullnose Stop	8', 10', 12'	(20)	
	H-870	1/2 x 7/8 Bullnose Stop	8', 10', 12'	(20)	
	H-906	7/16 x 1-3/8 PG Stop	R/L	(20)	
	H-936	7/16 x 1-3/8 OG Stop	7', 8', 10', 12'	(20)	
	H-952	7/16 x 1-1/4 Fillet	8', 10', 12'	(20)	
	H-994*	1-1/2 x 1-1/2 Cant Strip (Pine)	8', 10', 12', 14', 16'	250 lin.	
	H-995†	3/4 x 3/4 Cant Strip (Pine)	8', 10', 12', 14', 16'	500 lin.	

\* sold as 250 LF bundles only  
 † sold as 500 LF bundles only

(Prices subject to change)

April 1, 2024

# FINGER-JOINT PRIMED

## QUALITY BOARDS AND MOULDINGS

### 16' UNLESS OTHERWISE NOTED

#### FINGER-JOINT PINE, PRIMED S4S (GESSO COATED, INTERIOR USE)

<i>dimensions</i>	<i>suggested retail per LF</i>
1/2 x 4 .....	
1/2 x 6 .....	
1 x 2 .....	
1 x 3 .....	
1 x 4 .....	
1 x 5 .....	
1 x 6 .....	
1 x 7 .....	
1 x 8 .....	
1 x 10 .....	
1 x 12 .....	
5/4 x 4 .....	
5/4 x 6 .....	
5/4 x 8 .....	









#### WINDSORONE S4S

(MADE IN USA, INTERIOR & EXTERIOR USE)  
30 YEAR WARRANTY

<i>dimensions</i>	<i>suggested retail per LF</i>
1 x 2 .....	
1 x 3 .....	
1 x 4 .....	
1 x 5 .....	
1 x 6 .....	
1 x 8 .....	
1 x 10 .....	
1 x 12 .....	
5/4 x 4 .....	
5/4 x 6 .....	
5/4 x 8 .....	
5/4 x 12 .....	

**Ask us about WindsorONE mouldings!**







	<i>order #</i>	<i>description</i>	<i>lengths</i>	<i>bdl.</i>	<i>suggested retail per LF</i>
	PF-045	9/16 x 5-1/4 Crown	16'	(4)	
	PF-048	9/16 x 4-1/4 Crown	16'	(4)	
	PF-051	9/16 x 3-1/4 Crown	16'	(4)	
	PF-105	3/4 x 3/4 Quarter Round	16'	(20)	
	PF-126	1/2 x 3/4 Base Shoe	16'	(20)	
	PF-142	Screen Mould	8'	(20)	
	PF-180	1-1/4 x 2 Brick Mould	14', 16', 18'	(8)	
	PF-240	1-1/4 x 2-1/4 Hand Rail (2 x 3)	18'	(4)	
	PF-278	1-1/8 x 1-5/16 Back Band	16'	(8)	

**MORE FJP MOULDINGS ON NEXT PAGE!**

*(Prices subject to change)*

April 1, 2024

# FINGER-JOINT PRIMED MOULDINGS (CONT'D)

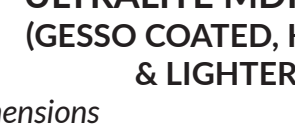
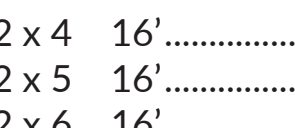
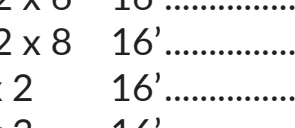
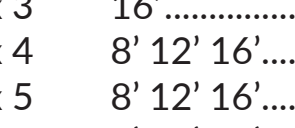
	order #	description	lengths	bdl.	suggested retail per LF
	PF-280	1-1/8 x 1-1/8 Back Band	16'	(8)	
	PF-283	1-3/8 x 2-7/16 Cap Mould	16'	(4)	
	PF-356	11/16 x 2-1/4 Colonial Csg	14'	(8)	
	PF-412	11/16 x 3-1/2 DBN Csg	17'	(6)	
	PF-452	11/16 x 2-1/2 DBN Csg	16'	(6)	
	PF-473	1/2 x 2-1/4 DBN Casing	16'	(6)	
	PF-618	9/16 x 5-1/4 OG Base	16'	(4)	
	PF-623	7/16 x 3-1/4 OG Base	16'	(6)	
	PF-625	7/16 x 2-1/4 OG Base	16'	(6)	
	PF-952	7/16 x 1-1/4 Fillet	12'	(20)	

*(WindsorONE PFJ mouldings also available. Call for current pricing and lead times.)*

## MDF BOARDS

16' UNLESS OTHERWISE NOTED

**ULTRALITE MDF - PRIMED S4S**  
(GESSO COATED, HIGHER QUALITY & LIGHTER WEIGHT)

**LITE MDF - PRIMED S4S**  
(ACRYLIC LATEX PRIMER)













*(May sub Ultralite at these prices if needed)*

dimensions	suggested retail per LF	dimensions	suggested retail per LF
1/2 x 4	16'	1/2 x 4	16'
1/2 x 5	16'	1/2 x 5	16'
1/2 x 6	16'	1/2 x 6	16'
1/2 x 8	16'	1/2 x 8	16'
1 x 2	16'	1 x 2	16'
1 x 3	16'	1 x 3	16'
1 x 4	8' 12' 16'	1 x 4	16'
1 x 5	8' 12' 16'	1 x 5	16'
1 x 6	8' 12' 16'	1 x 6	16'
1 x 7	16'	1 x 7	16'
1 x 8	8' 12' 16'	1 x 8	16'
1 x 10	16'	1 x 10	16'
1 x 12	16'	1 x 12	16'
5/4 x 4	16'	5/4 x 4	16'
5/4 x 5	16'	5/4 x 5	16'
5/4 x 6	16'	5/4 x 6	16'
5/4 x 8	16'	5/4 x 8	16'

*(Prices subject to change)*

April 1, 2024

# MDF MOULDINGS

	<i>order #</i>	<i>description</i>	<i>lengths</i>	<i>bdl.</i>	<i>suggested retail per LF</i>
	P-045	9/16 x 5-1/4 Crown	16'	(4)	
	P-048	9/16 x 4-1/4 Crown	16'	(4)	
	P-051	9/16 x 3-1/4 Crown	16'	(4)	
	P-300	1/2 x 1-1/2 Wedge Casing	14'	(12)	
	P-340	9/16 x 2-1/4 Moulded Casing	16'	(6)	
	P-356	5/8 x 2-1/4 Colonial Casing	7', 16'	(6)	
	P-444	5/8 x 3-1/4 Colonial Casing	16'	(6)	
	P-412	11/16 x 3-1/2 DBN Casing	8', 17'	(6)	
	P-452	11/16 x 2-1/2 DBN Casing	7', 16'	(6)	
	P-473	9/16 x 2-1/4 DBN Casing	16'	(6)	
	P-480	9/16 x 3-1/4 Fluted Casing	8'	(4)	
	P-508	5/8 x 2-1/2 Universal Mould	16'	(6)	
	P-611	7/16 x 3-7/8 Gingerbread Base	16'	(6)	
	P-618	1/2 x 5-1/4 OG Base	16'	(4)	
	P-623	1/2 x 3-1/4 OG Base	16'	(6)	
	P-625	1/2 x 2-1/4 OG Base	16'	(6)	
	P-635	9/16 x 5-1/4 Colonial Base	16'	(4)	
	P-755	9/16 x 5-5/8 Beaded Base	16'	(4)	

(Prices subject to change)











April 1, 2024

# CLEAR MAHOGANY

## QUALITY S4S FINISH LUMBER AND MOULDINGS

RANDOM LENGTH 6'-20', CALL FOR SPECIFIED LENGTH AVAILABILITY  
DETAILED CUT LISTS APPRECIATED - SAND BEFORE FINISHING

<i>dimensions</i>	<i>suggested retail per LF</i>
1/2 x 4.....	
1/2 x 6.....	
1 x 2.....	
1 x 3.....	
1 x 4.....	
1 x 5.....	
1 x 6.....	
1 x 8.....	
1 x 10.....	
1 x 12.....	

	<i>order #</i>	<i>description</i>	<i>lengths</i>	<i>bdl.</i>	<i>suggested retail per LF</i>
	M-100	11/16 x 11/16 Cove	8', 12'	(20)	
	M-105	11/16 x 11/16 Quarter Round	8', 12'	(20)	
	M-126	7/16 x 3/4 Base Shoe	8', 10', 12'	(20)	
	M-142	1/4 x 3/4 BN Screen Mould	8'	(25)	
	M-205	1 x 1 O.S. Corner	8'	(10)	
	M-206	11/16 x 11/16 O.S. Corner	8'	(10)	
	M-300	1/2 x 1-9/16 Combo Csg/Base	6'-16'	(20)	
	M-324	1/2 x 2-1/4 Bevel Casing	7', 8', 10', 12'	(10)	
	M-327	5/8 x 2-1/4 S/L Casing	7', 8', 10', 12'	(10)	
	M-727	3/8 x 2-3/4 S/L Base	8', 10', 12'	(10)	
	M-790	5/8 x 2-1/4 Sanitary Base	8', 10', 12'	(10)	
	M-865	3/8 x 1-5/8 Dbl BN Stop	8', 10'	(20)	
	M-866	3/8 x 1-1/4 Dbl BN Stop	8', 10'	(20)	

*(Prices subject to change)*



April 1, 2024

# CLEAR RED OAK

## QUALITY S4S FINISH LUMBER AND MOULDINGS





6', 8', 10', 12', 16' ADD 10% FOR 16'

CALL FOR SPECIFIED LENGTH AVAILABILITY

DETAILED CUT LISTS APPRECIATED - SAND BEFORE FINISHING

<i>dimensions</i>	<i>suggested retail per LF</i>
1/2 x 4 .....	
1/2 x 6 .....	
1 x 2 .....	
1 x 3 .....	
1 x 4 .....	
1 x 5 .....	
1 x 6 .....	
1 x 8 .....	
1 x 10.....	
1 x 12.....	
2 x 2 (1-5/16" x 1-5/16") .....	
2 x 4 (1-5/16" x 3-1/2") .....	
2 x 6 (1-5/16" x 5-1/2") .....	
2 x 8 (1-5/16" x 7-1/4") .....	

# CLEAR RED OAK MOULDINGS

	<i>order #</i>	<i>description</i>	<i>lengths</i>	<i>bdl.</i>	<i>suggested retail per LF</i>
	O-051	11/16 x 3-1/4 Crown	8', 10', 12'	(6)	
	O-093	3/4 x 3/4 Cove	8'	(20)	
	O-105	3/4 x 3/4 Quarter Round	8'	(20)	
	O-126	7/16 x 3/4 Base Shoe	8', 10', 12'	(20)	
	O-142	5/16 x 3/4 BN Screen Mould	8'	(25)	

MORE OAK MOULDINGS ON NEXT PAGE!

(Prices subject to change)

April 1, 2024

# CLEAR RED OAK MOULDINGS (CONT'D)



	<i>order #</i>	<i>description</i>	<i>lengths</i>	<i>bdl.</i>	<i>suggested retail per LF</i>
	O-205	1-1/16 x 1-1/16 O.S. Corner	8', 10'	(10)	
	O-206	3/4 x 3/4 O.S. Corner	8', 10'	(20)	
	O-239	3/4 x 3/4 Square	8'	(20)	
	O-293	3/4 x 2 Panel Cap	8', 10', 12'	(10)	
	O-300	9/16 x 1-1/2 Bevel Csg	7', 8', 10', 12'	(12)	
	O-324	1/2 x 2-1/4 Bevel Csg	7', 8', 10', 12'	(10)	
	O-356	1/2 x 2-1/4 Colonial Csg	7', 8', 10', 12'	(10)	
	O-473	7/16 x 2-1/4 Dbl BN Csg	7', 8', 10', 12'	(10)	
	O-626	3/8 x 2-3/4 OG Base	8', 10', 12'	(10)	
	O-724	3/8 x 2-3/4 S/L Base	8', 10', 12'	(10)	
	O-895	3/8 x 1-1/4 Counter Edge	8', 10', 12'	(20)	
	O-896	3/8 x 1-3/4 Counter Edge	8', 10', 12'	(10)	
	O-898	5/8 x 3-1/2 Counter Backsplash	8', 10', 12'	(6)	
	O-936	7/16 x 1-3/8 OG Stop	8'	(20)	

(Prices subject to change)

April 1, 2024

**SELECT KNOTTY ALDER**  
**QUALITY S4S FINISH LUMBER AND MOULDINGS**  
**RANDOM LENGTH 6'-16', CALL FOR SPECIFIED LENGTH AVAILABILITY**  
**DETAILED CUT LISTS APPRECIATED - SAND BEFORE FINISHING**

<b>(1 FACE EASED EDGE &amp; 1 FACE SQUARE EDGE)</b>	<b>(1 FACE EASED EDGE &amp; 1 FACE SQUARE EDGE)</b>
<i>dimensions</i>	<i>suggested retail per LF</i>
1/2 x 4 .....	1 x 8 .....
1 x 2 .....	1 x 10 .....
1 x 3 (also see A-452).....	1 x 12 .....
1 x 4 (also see A-412).....	5/4 x 4 .....
1 x 5 .....	5/4 x 6 .....
1 x 6 .....	

	<i>order #</i>	<i>description</i>	<i>lengths</i>	<i>bdl.</i>	<i>suggested retail per LF</i>
	A-412	11/16 x 3-1/2 DBN Casing	7'	(6)	
	A-412	11/16 x 3-1/2 DBN Casing	R/L	(6)	
	A-452	11/16 x 2-1/2 DBN Casing	7'	(6)	
	A-452	11/16 x 2-1/2 DBN Casing	R/L	(6)	
	A-736	1/2 x 5-1/2 BN Base(SE back)	R/L	(6)	





**HARD MAPLE-SELECT EASTERN WHITE**

**QUALITY S4S FINISH LUMBER AND MOULDINGS**

6', 8', 10', 12', 16' ADD 10% FOR 16'

**CALL FOR SPECIFIED LENGTH AVAILABILITY**  
**DETAILED CUT LISTS APPRECIATED - SAND BEFORE FINISHING**

<i>dimensions</i>	<i>suggested retail per LF</i>
1 x 2 .....	
1 x 3 .....	
1 x 4 .....	
1 x 5 .....	
1 x 6 .....	
1 x 8 .....	
1 x 12 (may be edge-glued).....	

	<i>order #</i>	<i>description</i>	<i>lengths</i>	<i>bdl.</i>	<i>suggested retail per LF</i>
	MA-126	7/16 x 3/4 Base Shoe	8', 10', 12'	(10)	
	MA-142	5/16 x 3/4 BN Screen Mould	8'	(10)	
	MA-896	3/8 x 1-3/4 Counter Edge	8', 10', 12'	(10)	
	MA-898	5/8 x 3-1/2 Backsplash	8', 10', 12'	(6)	

*(Prices subject to change)*



April 1, 2024

# HEMLOCK JAMBS

5% DISCOUNT FOR 10+ PAIR, 10% DISCOUNT FOR 30+ PAIR  
CALL FOR FULL UNIT PRICING



## DOUBLE-RABBETED INTERIOR JAMBS

<i>order #</i>	<i>description</i>	<i>suggested retail per pair</i>
J28	DR 4-9/16 81-5/8" PAIR.....	
J20	DR 4-9/16 COMBO 99" PAIR.....	
J33	DR 4-13/16 COMBO 81-5/8" PAIR.....	
J23	DR 4-13/16 COMBO 87" PAIR.....	
J18	DR 4-13/16 COMBO 99" PAIR.....	
J22	DR 5-1/4 COMBO 87" PAIR.....	
J42	DR 5-1/4 COMBO 99" PAIR.....	
J27	DR 6-9/16 COMBO 81-5/8" PAIR.....	
J24	DR 6-9/16 COMBO 99" PAIR.....	
J11	DR 6-13/16 COMBO 87" PAIR.....	
J25	DR 7-1/4 COMBO 87" PAIR.....	
J37	DR 7-1/4 COMBO 99" PAIR.....	



## VG VENEERED DOUBLE-RABBETED INTERIOR JAMBS

<i>order #</i>	<i>description</i>	<i>suggested retail per pair</i>
J13	VEN DR 4-9/16 81-5/8" PAIR.....	

(Prices subject to change)

April 1, 2024

**HEMLOCK JAMBS**  
**5% DISCOUNT FOR 10+ PAIR, 10% DISCOUNT FOR 30+ PAIR**  
**CALL FOR FULL UNIT PRICING**



**SINGLE-RABBETED EXTERIOR JAMBS WITH KERF**

<i>order #</i>	<i>description</i>	<i>suggested retail per pair</i>
J41	SR 4-9/16 KERF 83" PAIR.....	
J7	SR 4-9/16 KERF 87" PAIR.....	
J36	SR 5-1/4 KERF 87" PAIR.....	
J19	SR 6-9/16 KERF 83" PAIR.....	
J31	SR 6-9/16 KERF 87" PAIR.....	
J35	SR 6-9/16 KERF 99" PAIR.....	
J43	SR 7-1/4 KERF 87" PAIR.....	
J26	SR 7-1/4 KERF 99" PAIR.....	
J40	SR 8-7/8 KERF 99" PAIR.....	



**SINGLE-RABBETED EXTERIOR JAMBS W/OUT KERF**

<i>order #</i>	<i>description</i>	<i>suggested retail per pair</i>
J34	SR 7-1/4 NO KERF 99" PAIR.....	

*(Prices subject to change)*

April 1, 2024

**FINGER-JOINT PRIMED JAMBS**  
**5% DISCOUNT FOR 10+ PAIR, 10% DISCOUNT FOR 30+ PAIR**  
**CALL FOR FULL UNIT PRICING**



**DOUBLE-RABBETED INTERIOR JAMBS**

<i>order #</i>	<i>description</i>	<i>suggested retail per pair</i>
J1	DR 4-9/16 81-5/8" PAIR.....	
J5	DR 4-9/16 97-5/8" PAIR.....	
J32	DR 4-9/16 COMBO 97-5/8" PAIR .....	
J30	DR 4-13/16 COMBO 81-5/8" PAIR.....	
J2	DR 4-13/16 COMBO 85-5/8" PAIR.....	
J29	DR 4-13/16 COMBO 97-5/8" PAIR.....	
J14	DR 5-1/4 COMBO 85-5/8" PAIR.....	
J4	DR 6-9/16 COMBO 81-5/8" PAIR .....	
J8	DR 6-9/16 COMBO 97-5/8" PAIR .....	
J10	DR 7-1/4 COMBO 85-5/8" PAIR.....	
J17	DR 7-1/4 COMBO 97-5/8" PAIR.....	



**SINGLE-RABBETED EXTERIOR JAMBS WITH KERF**

<i>order #</i>	<i>description</i>	<i>suggested retail per pair</i>
J3	SR 4-9/16 KERF 83" PAIR.....	
J12	SR 5-1/4 KERF 87" PAIR .....	
J6	SR 6-9/16 KERF 83" PAIR.....	
J21	SR 6-9/16 KERF 99" PAIR.....	
J9	SR 7-1/4 KERF 83" PAIR .....	
J16	SR 7-1/4 KERF 99" PAIR .....	
J39	SR 8-7/8 KERF 99" PAIR.....	



*(Prices subject to change)*

April 1, 2024



# FIR VENEER - KNOTTY ALDER - CLEAR PINE JAMBS

**5% DISCOUNT FOR 10+ PAIR, 10% DISCOUNT FOR 30+ PAIR, CALL FOR FULL UNIT PRICING**

## VG FIR VENEERED JAMBS

	<i>order #</i>	<i>description</i>	<i>suggested retail per pair</i>
	J44	DR 4-9/16 81-5/8" PAIR.....	
	J46	SR 4-9/16 KERF 87" PAIR.....	
	J45	SR 6-9/16 KERF 87" PAIR.....	
	J73	SR 7-1/4 KERF 98" PAIR..... (2" Solid Rip Strip)	

## KNOTTY ALDER JAMBS

	<i>order #</i>	<i>description</i>	<i>suggested retail per pair</i>
	J15	DR 4-9/16 COMBO 81-5/8" PAIR .....	
	J71	SR 7-1/4 KERF 99" PAIR.....	

## CLEAR PINE JAMBS

	<i>order #</i>	<i>description</i>	<i>suggested retail per pair</i>
	J74	DR 4-9/16 81-5/8" PAIR.....	



(Prices subject to change)



April 1, 2024

# WOOD SILLS - JAMB STOCK - MULL POST ASTRAGALS - SHIMS





## DOUGLAS FIR SILLS - (R/L 6'-20')

	size	description	suggested retail per LF
	2 x 8 (net 1-3/8 x 7-1/16)	Bevel Sill MG .....	
	2 x 8 (net 1-3/8 x 7-1/16)	Rabbeted Door Sill MG .....	
	2 x 10 (net 1-3/8 x 8-15/16)	Rabbeted Door Sill MG .....	

## DOUGLAS FIR JAMB STOCK - 1-13/16 RABBET - (R/L 6'-20')

	size	description	suggested retail per LF
	1-1/4 X 5-1/4	SR Jamb MG .....	
	1-1/4 X 7	SR Jamb MG .....	
	1-1/4 X 9	SR Jamb MG .....	

## FIR - HEMLOCK - PRIMED ASTRAGALS AND MULL POSTS

	size - description	length	suggested retail per each
	2" x 4-3/8 VG Fir E.G. Mull Post	98" .....	
	2" x 4-3/8 VG Hemlock E.G. Mull Post	98" .....	
	2" x 4-3/8 Primed Finger-joint Mull Post	98" .....	
	F-1317 Kerfed 3" Fir Astragal	7' .....	
	F-1317 Kerfed 3" Fir Astragal	8' .....	
	H-1312 Kerfed 3" Hemlock Astragal	7' .....	
	H-1312 Kerfed 3" Hemlock Astragal	8' .....	
	F-1311 1-3/4" T-Offset Fir Astragal	8' .....	
	H-1315 1-3/8" T Hemlock Astragal	7' .....	
	H-1315 1-3/8" T Hemlock Astragal	8' .....	

## CEDAR SHIMS

	suggested retail per carton
 480 Shims per Carton (30 bdl. of 16) .....	
(sold in full cartons only)	

(Prices subject to change)

April 1, 2024

# SILLS & EXTENDERS

## FULL BOXES 10% DISCOUNT

order #	length	color	#per box	suggested retail per each
---------	--------	-------	----------	---------------------------

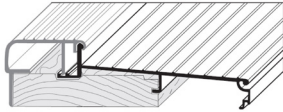

### FIXED 5-5/8" HI-DAM INSWING SILL WITH VINYL CAP

D10	74"	Aluminum	5	
D17	74"	Bronze	5	

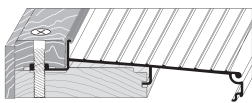

### ADJUSTABLE 5-5/8" HI-DAM INSWING SILL WITH OAK CAP

D18	74"	Aluminum	5	
D12	74"	Bronze	5	
D40	148"	Bronze	2	



### ADJUSTABLE 7-13/16" HI-DAM INSWING SILL WITH OAK CAP

D20	74"	Aluminum	4	
D13	74"	Bronze	4	
D41	148"	Bronze	2	



### 5-5/8" OAK OUTSWING SILLS

D14	74"	Aluminum	5	
D16	74"	Bronze	5	

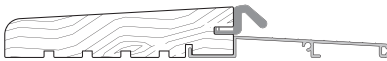

### 7-3/8" OAK OUTSWING SILLS

D19	74"	Aluminum	4	
D15	74"	Bronze	4	



### 2" EXTENDERS FOR 5-5/8" INSWING SILLS

D11	74"	Aluminum	30	
D21	74"	Bronze	30	

(Prices subject to change)

April 1, 2024

# DOOR SHOES, SADDLES & WEATHERSTRIP

## FULL BOXES 10% DISCOUNT

order #	size	color	#per box	suggested retail per each
---------	------	-------	----------	---------------------------



### POLYVINYL DOOR SHOES

D30	31-3/4"	Brown	25	
D24	35-3/4"	Brown	25	



D28	37"	Brown	40	
D32	48"	Brown	40	
D25	37"	White	40	
D33	48"	White	40	



D26	36"	Brown	25	
D31	48"	Brown	25	
D27	36"	White	25	
D29	48"	White	25	

### ALUMINUM THRESHOLD-SILLS, SADDLES (72" LONG)



D23	5"	Aluminum	10	
D42	5"	Bronze	10	
D22	7"	Aluminum	10	
D43	7"	Bronze	10	

### FOAM WEATHERSTRIP

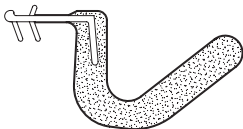



WB85	85"	Brown	125	
WB96	96"	Brown	125	
WW85	85"	White	125	
WW96	96"	White	125	

(Prices subject to change)

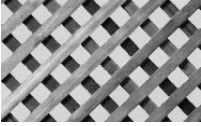
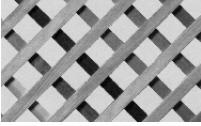
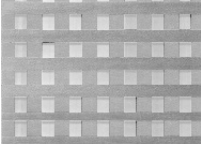

April 1, 2024

# QUALITY CEDAR LATTICE

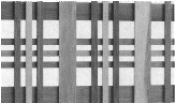
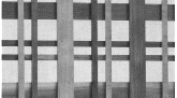
5% DISCOUNT FOR 15+ SHEETS, 10% DISCOUNT FOR 30+ SHEETS

	<i>description</i>	<i>order #</i>	<i>suggested retail per sheet</i>
	<b>DIAGONAL PRIVACY</b>	<b>1-7/8" OPENING (70% SHADE)</b>	<b>Non-rust Stainless Steel Staples</b>
	3/8" x 4 x 8 Clear Face	810.1095.....	
	3/8" x 1 x 8 #1	810.1060S .....	
	13/16" x 4 x 8 #1 H.D.	810.1140S .....	
	<b>DIAGONAL GARDEN</b>	<b>2-5/8" OPENING (50% SHADE)</b>	<b>Galvanized Staples</b>
	3/8" x 4 x 8 Select	810.1080.....	
	13/16" x 4 x 8 Mill Run H.D.	810.1135.....	
	<b>SQUARE PRIVACY</b>	<b>1-7/8" OPENING (70% SHADE)</b>	<b>Non-rust Stainless Steel Staples</b>
	3/8" x 4 x 8 #1	810.1114S .....	
	13/16" x 4 x 8 #1 H.D.	810.1154S .....	
	<b>MODERNA PANEL SCREEN</b>	<b>3/4" OPENING</b>	<b>Non-rust Stainless Steel Staples</b>
	13/16" x 4 x 8 Clear	810.1209.....	
	<b>ESTATE LATTICE - SQUARE PATTERN (Wide &amp; Narrow Lath)</b>		<b>Non-rust Stainless Steel Staples</b>
	Catalina 13/16" x 3 x 6 #1 Premium	810.3098.....	
	Monterey 13/16" x 3 x 6 #1 Premium	810.3097.....	

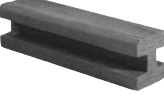
## CLEAR CEDAR LATTICE MOULDINGS - 8' LENGTHS ONLY











	<i>description</i>	<i>order #</i>	<i>bdl</i>	<i>suggested retail per each</i>
	1/2" groove	1 x 2 Standard Cap .....	815.1625 .....	(18).....
	1/2" groove	2 x 2 Standard Divider .....	815.1630 .....	(9).....
	7/8" groove	2 x 2 H.D. Cap.....	815.1640 .....	(9).....
	7/8" groove	2 x 2 H.D. Divider .....	815.1645 .....	(9).....

(Prices subject to change)

April 1, 2024

# QUALITY CEDAR POST CAPS

## FULL BOXES 10% DISCOUNT

	<i>description</i>	<i>size</i>	<i>order #</i>	<i>ctn.</i>	<i>suggested retail per each</i>
	Ball Finial - Georgian	4 x 4	870.1381.....	12.....	
	Flat Top	4 x 4	870.1382.....	12.....	
	Pyramid	4 x 4	870.1383.....	12.....	
	Pyramid	6 x 6	870.1641.....	8.....	
	Glass-Black Opaque	4 x 4	870.3084.....	9.....	
	Glass-Cobalt Blue	4 x 4	870.3085.....	9.....	
	Glass-Cobalt Blue	6 x 6	870.3207.....	8.....	
	Glass-Forest Green	4 x 4	870.3086.....	9.....	
	Glass-Amber	4 x 4	870.3087.....	9.....	
	Copper Pyramid	4 x 4	870.1384.....	12.....	
	Copper Pyramid	6 x 6	870.1669.....	8.....	
	Small Copper Pyramid	4 x 4	870.1388.....	12.....	
	Copper Flat Top	4 x 4	870.1387.....	12.....	
	Ball Top	4 x 4	870.1392.....	6.....	
	Cottage Flat Top	4 x 4	870.1391.....	12.....	
	Copper Crown	4 x 4	870.1845.....	24.....	
	Standard-Flat Bottom	4 x 4 (full ctn. only)	870.0000.....	24.....	
	Standard-Flat Bottom	6 x 6 (full ctn. only)	870.0001.....	10.....	

### WOODWAY PACKAGED T & G PANELING, 5/16" THICK X 3-1/2" WIDE

<i>order #</i>	<i>name</i>	<i>face</i>	<i>grade</i>	<i>length</i>	<i>suggested retail per pack</i>
	<b>PINE (weight 12 1/2 lbs per pkg.)</b>				<b>covers 14 S.F. per pkg</b>
830.1981	Pine Cottage Lake	Dbl. Beaded	Rustic	8' only	
830.1970	White Springs	V-Smooth	T.K.	8' only	
(48 Lin. per 8' Pkg.)		(36 Pkg. per Pallet - Full Pallets Deduct 10%)		(T.K. = Tight Knot)	

(Prices subject to change)

April 1, 2024

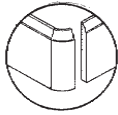

# SOFTLINE WOOD CORNERS



<i>order #</i>	<i>matches</i>	<i>ctn.</i>	<i>suggested retail per each</i>
SCH-356	HEM Colonial Csg. 1 1/16 x 2-1/4 .....	50 .....	
SCM-356	MDF Colonial Csg. 5/8 x 2-1/4 .....	50 .....	
SCH-412	HEM Univ. Dbl. BN 23/32 x 3-1/2 .....	50 .....	
SCO-451	OAK Univ. Dbl. BN 3/4 x 2-3/4 .....	25 .....	
SCH-473	HEM Double BN Csg. 1/2 x 2-1/4 .....	50 .....	
SCM-618	MDF OG Base 1/2 x 5-1/4 .....	50 .....	
SCH-618	HEM OG Base 9/16 x 5-1/4 .....	50 .....	
SCH-623	HEM OG Base 7/16 x 3-1/4 .....	50 .....	
SCM-623	MDF OG Base 1/2 x 3-1/4 .....	50 .....	

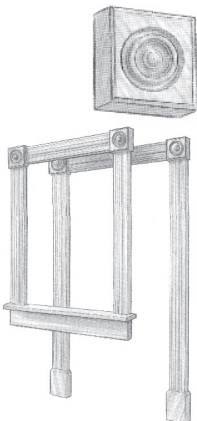

# BULLSEYE ROSETTES

<i>order #</i>	<i>description</i>	<i>ctn.</i>	<i>suggested retail per each</i>
SBR-312	3/4 x 3-1/2 Alder (edge glued) .....	100 .....	
SBM-312	3/4 x 3-1/2 MDF Primed .....	100 .....	
SBM-212	3/4 x 2-1/2 MDF Primed .....	200 .....	

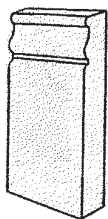

# PLINTH BLOCKS

<i>order #</i>	<i>description</i>	<i>ctn.</i>	<i>suggested retail per each</i>
SPB-312	3/4 x 3-1/2 x 6-1/2 Alder (edge glued) .....	50 .....	
SPM-312	3/4 x 3-1/2 x 6-1/2 MDF Primed .....	50 .....	

(Prices subject to change)



April 1, 2024

**Nelson** MANUFACTURER DIRECT WOOD DOORS  
INTERNATIONAL

# HEMLOCK INTERIOR

## HEMLOCK FLAT PANEL SHAKER

<i>order #</i>	<i>measurements</i>	<i>suggested retail per each</i>
----------------	---------------------	----------------------------------



### HEMLOCK 3 PANEL SHAKER

S33-1/6	1'6" x 1-3/8" x 80"
S33-1/10	1'10" x 1-3/8" x 80"
S33-2/0	2'0" x 1-3/8" x 80"
S33-2/2	2'2" x 1-3/8" x 80"
S33-2/4	2'4" x 1-3/8" x 80"
S33-2/6	2'6" x 1-3/8" x 80"
S33-2/8	2'8" x 1-3/8" x 80"
S33-2/10	2'10" x 1-3/8" x 80"
S33-3/0	3'0" x 1-3/8" x 80"

### S33 BIFOLDS

S33B-2/0	2'0" x 1-3/8" x 79"
S33B-2/6	2'6" x 1-3/8" x 79"
S33B-3/0	3'0" x 1-3/8" x 79"



### HEMLOCK 5 PANEL SHAKER

S55-1/6	1'6" x 1-3/8" x 80"
S55-1/10	1'10" x 1-3/8" x 80"
S55-2/0	2'0" x 1-3/8" x 80"
S55-2/2	2'2" x 1-3/8" x 80"
S55-2/4	2'4" x 1-3/8" x 80"
S55-2/6	2'6" x 1-3/8" x 80"
S55-2/8	2'8" x 1-3/8" x 80"
S55-2/10	2'10" x 1-3/8" x 80"
S55-3/0	3'0" x 1-3/8" x 80"

### S55 BIFOLDS

S55B-2/0	2'0" x 1-3/8" x 79"
S55B-2/6	2'6" x 1-3/8" x 79"
S55B-3/0	3'0" x 1-3/8" x 79"

Allow 2 weeks for delivery. 5% discount on 15 or more doors, any mix styles and sizes. Call for quote on full-unit pricing. Bifolds are boxed, include hardware and pre-installed hinges. Warranty - 1 year for any manufacturing defects: i.e. veneer delam, cracks, splits, glue spots, etc.







April 1, 2024



## HEMLOCK EXTERIOR

### HEMLOCK LOW EMISSION INSULATED GLASS

order #	measurements	suggested retail per each
---------	--------------	---------------------------

#### 3 CLEAR INS. GLASS LITES 2 FLAT PANEL

X23-28	2'8" x 1-3/4" x 80"	
X23-210	2'10" x 1-3/4" x 80"	
X23-30	3'0" x 1-3/4" x 80"	



#### MATCHING GLASS OVER FLAT PANEL SIDE LITE

X23SDL	14" x 1-3/4" x 80"	
--------	--------------------	--

#### MATCHING 1 FULL GLASS SIDE LITE

X231SDL	14" x 1-3/4" x 80"	
---------	--------------------	--

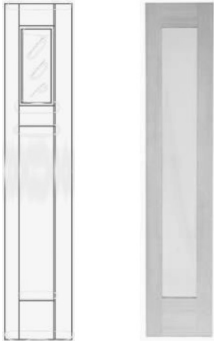

#### 6 CLEAR BEVELLED INS. GLASS LITES 3 RAISED PANELS

X36-2/8	2'8" x 1-3/4" x 80"	
X36-2/10	2'10" x 1-3/4" x 80"	
X36-3/0	3'0" x 1-3/4" x 80"	

#### MATCHING 2 GLASS OVER 1 RAISED PANEL SIDE LITE

X36SDL	14" x 1-3/4" x 80"	
--------	--------------------	--



Allow 2 weeks for delivery. 5% discount on 15 or more doors, any mix styles and sizes. Call for quote on full-unit pricing. Bifolds are boxed, include hardware and pre-installed hinges. Warranty - 1 year for any manufacturing defects: i.e. veneer delam, cracks, splits, glue spots, etc.

April 1, 2024

**Nelson** MANUFACTURER DIRECT WOOD DOORS  
INTERNATIONAL

## HEMLOCK EXTERIOR

### HEMLOCK INSULATED LOW EMISSION GLASS



<i>order #</i>	<i>measurements</i>	<i>suggested retail per each</i>
<b>HEMLOCK CROSSBUCK 9 LITE</b>		
EHF803528	2'8" x 1-3/4" x 80"	
EHF803521	2'10" x 1-3/4" x 80"	
EHF803530	3'0" x 1-3/4" x 80"	



<b>CLEAR LOW-E INS. GLASS 1-LITE</b>		
EHF800224	2'4" x 1-3/4" x 80"	
EHF800226	2'6" x 1-3/4" x 80"	
EHF800228	2'8" x 1-3/4" x 80"	
EHF800221	2'10" x 1-3/4" x 80"	
EHF800230	3'0" x 1-3/4" x 80"	



<b>HEMLOCK DENTIL SHELF</b>	
XFDSH-10	10"
XFDSH-32	23"
XFDSH-36	27"

Allow 2 weeks for delivery. 5% discount on 15 or more doors, any mix styles and sizes. Call for quote on full-unit pricing. Bifolds are boxed, include hardware and pre-installed hinges. Warranty - 1 year for any manufacturing defects: i.e. veneer delam, cracks, splits, glue spots, etc.

April 1, 2024

**Nelson** MANUFACTURER DIRECT WOOD DOORS  
INTERNATIONAL

## HEMLOCK EXTERIOR



<i>order #</i>	<i>measurements</i>	<i>suggested retail per each</i>
<b>9-LITE OVER 2 RAISED PANELS, LOW-E GLASS</b>		
EHF894428	2'8" X 1-3/4" X 80"	
EHF894430	3'0" X 1-3/4" X 80"	



<b>3/4-LITE OVER 1 RAISED PANEL, LOW-E GLASS</b>		
EHF850126	2'6" X 1-3/4" X 80"	
EHF850128	2'8" X 1-3/4" X 80"	
EHF850121	2'10" X 1-3/4" X 80"	
EHF850130	3'0" X 1-3/4" X 80"	

Allow 2 weeks for delivery. 5% discount on 15 or more doors, any mix styles and sizes. Call for quote on full-unit pricing. Bifolds are boxed, include hardware and pre-installed hinges. Warranty - 1 year for any manufacturing defects: i.e. veneer delam, cracks, splits, glue spots, etc.



April 1, 2024

**Nelson** MANUFACTURER DIRECT WOOD DOORS  
INTERNATIONAL

## INTERIOR PRIMED WHITE



<i>order #</i>	<i>measurements</i>	<i>suggested retail per each</i>
<b>IPR760 PRIMED 3 PANEL SHAKER</b>		
IPR76016	1'6" x 1-3/8" x 80"	
IPR76018	1'8" x 1-3/8" x 80"	
IPR76020	2'0" x 1-3/8" x 80"	
IPR76024	2'4" x 1-3/8" x 80"	
IPR76026	2'6" x 1-3/8" x 80"	
IPR76028	2'8" x 1-3/8" x 80"	
IPR76021	2'10" x 1-3/8" x 80"	
IPR76030	3'0" x 1-3/8" x 80"	
<b>IPRB760 PRIMED 3 PANEL BI-FOLDS</b>		
IPRB76020	2'0" x 1-3/8" x 79"	
IPRB76026	2'6" x 1-3/8" x 79"	
IPRB76030	3'0" x 1-3/8" x 79"	

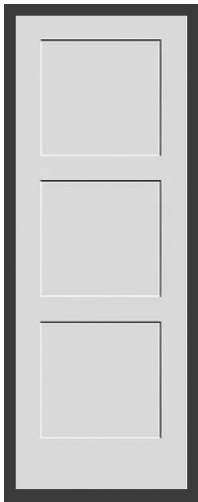

<b>IPR730 PRIMED 3 EQUAL PANEL SHAKER</b>		
IPR73016	1'6" x 1-3/8" x 80"	
IPR73020	2'0" x 1-3/8" x 80"	
IPR73024	2'4" x 1-3/8" x 80"	
IPR73026	2'6" x 1-3/8" x 80"	
IPR73028	2'8" x 1-3/8" x 80"	
IPR73021	2'10" x 1-3/8" x 80"	
IPR73030	3'0" x 1-3/8" x 80"	

Allow 2 weeks for delivery. 5% discount on 15 or more doors, any mix styles and sizes. Call for quote on full-unit pricing. Bifolds are boxed, include hardware and pre-installed hinges. Warranty - 1 year for any manufacturing defects: i.e. veneer delam, cracks, splits, glue spots, etc.







April 1, 2024

**Nelson** MANUFACTURER DIRECT WOOD DOORS  
INTERNATIONAL

## ALDER EXTERIOR

<i>order #</i>	<i>measurements</i>	<i>suggested retail per each</i>
----------------	---------------------	----------------------------------

**ER8002 ALDER LOW-E GLASS 1-LITE**

ER800226 2'6" X 1-3/4" X 80"

ER800228 2'8" X 1-3/4" X 80"

**3/4-LITE OVER 1 RAISED PANEL, LOW-E GLASS**

ER682628 2'8" X 1-3/4" X 80"

ER6826210 2'10" X 1-3/4" X 80"

ER682630 3'0" X 1-3/4" X 80"

ER6826308 3'0" X 1-3/4" X 96"

Allow 2 weeks for delivery. 5% discount on 15 or more doors, any mix styles and sizes. Call for quote on full-unit pricing. Bifolds are boxed, include hardware and pre-installed hinges. Warranty - 1 year for any manufacturing defects: i.e. veneer delam, cracks, splits, glue spots, etc.

April 1, 2024

# WEST COAST LUMBER STANDARD GRADING RULES #17

## FINISH

ALL WEST COAST SPECIES (EXCEPT CEDAR)  
VG, FG OR MG, KD - 2" AND THINNER - 2" AND WIDER

101. FINISH is customarily shipped kiln dried and surfaced four sides. Grade descriptions are based on a piece 8" wide and 12' long. The number of characteristics in larger or smaller pieces may vary in proportion to the size of the piece. Pieces of FINISH 5" and narrower are graded from the best face and both edges. Pieces 6" and wider are graded from the best face and one edge.

There are two grades of FINISH: "C & BTR" and "D."

Unless otherwise specified, pieces are VG, FG or MG at shipper's option.

101-c. "C & BTR"-VG, FG or MG FINISH.

This grade includes the highest type products produced from the clear portion of the log. FINISH of this grade is recommended and widely used for interior trim and cabinet work with natural, stain or enamel finishes where finest appearance is important.

Characteristics and limiting provisions are:  
Medium stained sapwood. Heart stain firm.  
Short splits in not more than 5% of the pieces.  
Small seasoning checks, well scattered.  
Occasional very light skips on edge or back.  
Light torn or raised grain.

Two small, sound, tight knots or equivalent smaller, or a small pitch streak or four small pitch or bark pockets or equivalent smaller.  
Warp - light in occasional pieces.  
A 3" cutout 3' or more from either end of pieces 12' and longer is permissible in 5% of the shipment if the piece is otherwise of high type.

ALL SPECIFIED-LENGTH ORDERS SUBJECT TO AVAILABILITY AND SUBSTITUTION AT THE TIME WE FILL YOUR ORDER.  
ALL SOLID WOOD ITEMS ARE PLANER-FINISHED AND SHOULD BE SANDED BEFORE STAINING OR FINISHING.  
WE CANNOT ACCEPT CLAIMS ON MATERIALS THAT ARE FINISHED WITHOUT SANDING.

Estimated Shipping Weight Per 100 Lineal Feet For Finish Lumber

	FIR	HEMLOCK POPLAR	MAHOGANY	OAK MAPLE	PINE ALDER	MDF PFJ
1x2	33	30	27	35	25	30
1x3	50	45	40	55	38	45
1x4	67	60	53	75	50	60
1x5	83	75	67	105	-	75
1x6	100	90	80	120	75	90
1x8	133	120	107	165	100	120
1x10	166	150	133	205	125	150
1x12	200	180	160	250	150	180
1-1/4x4	83	75	67	-	-	75
1-1/4x6	125	113	100	-	-	113
2x2	67	60	53	60		
2x3	100	90	80			
2x4	133	120	107	140		
2x6	200	180	160	230		
2x8	267	240	213	280		
2x10	333	300	266			
2 x 12	400	360	320			

## Discounts and Specified Charges

Material and prices are subject to availability and change without notice.

### Terms:

- 1% 10th Prox, Net 25th
- Finance Charges: 1-1/2% per month on past due balances
- Discounts Apply to Current Accounts Only
- Handling Fee may be added to orders below \$500
- Specified Length Charge +10%

Please contact sales for special quantity discounts

### Returns:

- Returns need prior approval
- Returns are subject to a restocking charge
- Special orders-no refunds
- Stock must be clean and in original condition

### U.P.S. Charge:

\$10/package plus normal U.P.S.charges (or U.S. Mail)

(Prices subject to change)

April 1, 2024

Estimated Shipping Weight Per 1000 Lineal Feet For Wood Mouldings - Hemlock, Pine, Alder, Mahogany, Poplar, and MDF. Add 40% for Oak and Maple.														Conversion Table		
		THICKNESS												Multiply lineal footage times conversion factor to find Board Foot Amount. (example - 1x3: 1000 LIN FT x .25=250 BD FT)		
WIDTH		1/4	9/32	5/16	3/8	7/16	1/2	9/16	5/8	11/16	3/4	1-1/8	1-3/8			
1/4	9															
5/16	12															
3/8	14	16	17	21												
1/2	19	21	23	28	33	37										
5/8	23	26	29	35	41	47	53	59	59							
3/4	28	32	35	42	49	56	63	70	70	84						
7/8	33	37	41	49	57	66	74	82	82	98						
1	37	42	47	56	66	75	83	94	94	112						
1-1/8	42	47	53	63	74	84	95	105	105	126	190					
1-1/4	47	53	59	70	82	94	106	117	117	140	211					
1-3/8	52	58	64	77	90	103	116	129	129	154	232	283				
1-1/2	56	63	70	84	98	112	126	140	140	169	253	309				
1-5/8	61	68	76	91	104	122	137	152	152	183	274	335				
1-3/4	66	74	82	98	117	131	147	164	164	197	295	360				
2				112	131	150	169	187	187	225	337	412				
2-1/8				126	148	169	211	211	211	253	379	463				
2-1/4					164	187	222	234	234	281	421	515				
2-1/2					170	197	231	246	246	295	442	541				
2-5/8					180	206	252	257	257	309	463	566				
2-3/4							274	281	281	337	505	618				
3								304	304	365	548	669				
3-1/4								328	328	393	590	721				
3-1/2								339	339	407	611	750				
3-5/8								351	351	421	632	772				
3-3/4								374	374	477	716	875				
4-1/4								445	445	534	800	978				
4-3/4								515	515	618	927	1356				
5-1/2								538	538	646	969	1420				
5-3/4																

1x2	.16667	5/4x2	.20833
1x3	.25	5/4x3	.3125
1x4	.33333	5/4x4	.41667
1x5	.41667	5/4x5	.52083
1x6	.5	5/4x6	.625
1x7	.5833	5/4x8	.83333
1x8	.66667	5/4x10	1.04167
1x10	.83333	5/4x12	1.25
1x12	1.0		
2x2	.33333	3x3	.75
2x3	.5	3x4	1.0
2x4	.66667	3x6	1.5
2x5	.83333	3x8	2.0
2x6	1.0	3 x 10	2.5
2x8	1.3333	3x12	3.0
2x10	1.6667	4x4	1.3333
2x12	2.0	4x6	2.0
6x6	3.0	4x8	2.6667
		4x10	3.3333
		4x12	4.0

## DELIVERY SCHEDULE

<b>MONDAY</b>	<b>Seattle North to Bellingham, Eastside</b>
<b>TUESDAY</b>	<b>Seattle South to Rochester</b>
<b>WEDNESDAY</b>	<b>Arlington to Bellingham, Whidbey Island</b>
<b>THURSDAY</b>	<b>Seattle North to Marysville, Eastside</b>
<b>FRIDAY</b>	<b>Seattle South to Shelton, Peninsula</b>

**Trucks loaded at 3:00 PM**  
**Orders need to be in by Noon for Following Day Delivery**